

MTL831B

IS Analogue Multiplexer Transmitter



1	About this manual	1
1.1	Related documents	1
1.2	Product description	1
2	Getting started	1
3	Mechanical installation	1
3.1	Location	1
3.2	Mounting options	1
4	CONNECTIONS	3
4.1	RTD inputs	3
4.2	THCs and mV inputs	5
4.3	Mixed inputs	5
4.4	Highway connections	5
4.5	MTL3052 digital isolator	6
4.6	Multi-transmitter connections	6
4.7	Cable screens	7
5	Configuration	7
5.1	Transmitter Address	7
5.2	RTD mode setting	7
6.	ATEX information	8



MTL831B transmitter and MTL838B-MBF receiver

1 ABOUT THIS MANUAL

The purpose of this manual is to provide the user with information on the installation, connection and configuration of the MTL831B analogue multiplexer transmitter.

"Cautionary Note: In common with all other electrical apparatus installed in hazardous areas, this apparatus must only be installed, operated and maintained by competent personnel. Such personnel shall have undergone training, which included instruction on the various types of protection and installation practices, the relevant rules and regulations, and on the general principles of area classification. Appropriate refresher training shall be given on a regular basis. [See clause 4.2 of EN 60079-17].

This instruction manual supplements the requirements of nationally accepted codes of practice, for example, IEC/EN 60079-14 in Europe and the National Electrical Code, combined with ANSI/ISA-RP 12.12 in the USA. All installations should comply with the relevant sections of these codes.

In addition, particular industries or end users may have specific requirements relating to the safety of their installations, and these requirements should also be met".

1.1 Related documents

This manual does NOT cover the connection or configuration of the MTL838B-MBF receiver. For details of this item consult:

- ◆ **INM838B-MBF.**

Additional application information is available in:

- ◆ **AN9010.**

1.2 Product description

The MTL831B analogue transmitter can transfer a number of hazardous area input signals to the safe area down a data highway consisting of a single twisted pair cable. It is intrinsically safe and can therefore be mounted in Zone 0 hazardous areas or Class I, Division 1 hazardous locations.

The MTL831B can monitor up to 16 inputs from THC or millivolt sources or up to 15 inputs from 2, 3 or 4-wire RTDs.

Two (i.e. dual redundant) data highway outputs are provided that can carry both signal and power over distances up to 3km, depending on the application, the cable and the (noise) environment - see Section 4.4. The highway cables can be simple twisted-wire pairs or pairs of wire within an IS multi-core cable.

Modbus® is a registered trademark of Schneider Automation Inc.

At the other end of the data highway, MTL838B-MBF receivers are used to translate the information transmitted from the MTL831B. The MTL838B-MBF provides a Modbus® serial data output representation of the inputs together with status information.

When the MTL831B transmitter is mounted in the hazardous area, each data highway *must* be protected by an MTL3052 digital isolator mounted in the safe area.

2 GETTING STARTED

Installation of the MTL831B multiplexer transmitter is divided into three main topics.

- ◆ **Mechanical Installation** - how to mount the MTL831B and how it may be fitted into our enclosure.
- ◆ **Electrical Connections** - the sensor and highway connections. If units are installed in our enclosures, it details any special wiring arrangements.
- ◆ **Configuration** - the address and input mode selection by the setting of internal switches.

Note: A new user might find it helpful to set up the system, or a simple version of it, in an indoor test area to gain familiarisation before undertaking installation on site.

3 MECHANICAL INSTALLATION

3.1 Location

The MTL831B can be installed in either safe or hazardous areas (including Zone 0 or Division 1) depending upon the requirements of the application.

3.2 Mounting options

The unit can be mounted on T-section DIN-rail or onto a flat surface. Eaton has a range of enclosures - ENC8, ENC8-SS, ENC83 or ENC83-SS - to provide suitable IP67 protection if the transmitter is located in an exposed area.

3.2.1 Mounting on T-section DIN-rail (Figure 1)

Hook the side opposite the central mounting clip onto standard 35mm DIN46277 T-section rail and push downwards until the unit clicks into place.

To remove, ease the central clip below the base of the unit outwards (with a screwdriver) and unhook the clips on the other side.

3.2.2 Mounting on a flat surface (figures 2 and 3)

Turn the unit upside down.

With a screwdriver, apply an anti-clockwise force against the retaining arm of one of the base clips to release it from its recess.

Hold the arm in this position and slide the clip outwards.

Release the retaining arm to engage the tooth in the base moulding.

Adjust the position of the other two clips with a similar procedure.

Mount on any flat surface using three M4 bolts or screws (or other suitable fasteners with a shank diameter of 4mm or less) through the three clips according to the mounting centres shown in figure 3.

3.2.3 Mounting in an ENC8, ENC8-SS, ENC83 or ENC83-SS enclosure (figure 4)

Remove the upper and/or lower undrilled gland plates and drill suitable holes for the entry glands required. Possible hole configurations are listed in the table.

Mount the unit on the internal T-section rail of the enclosure as described in (1).

Mount the enclosure on any flat surface using four M8 bolts (or other suitable fasteners with a shank diameter of 8mm or less) through the four fixed lugs according to the mounting centres shown in figure 4.

Table 1 Recommended gland entries

Entry size (mm)	Recommended maximum no. of entries	Minimum distance between centres (mm)
16	13	40
20	9	45
25	6	50
32	4	64
40	3	80

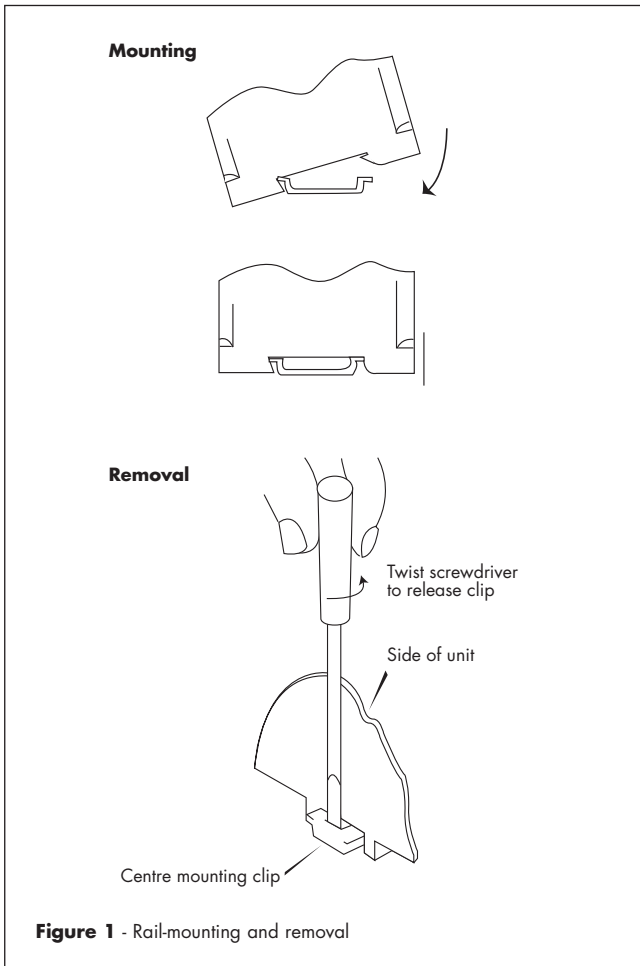

Figure 1 - Rail-mounting and removal

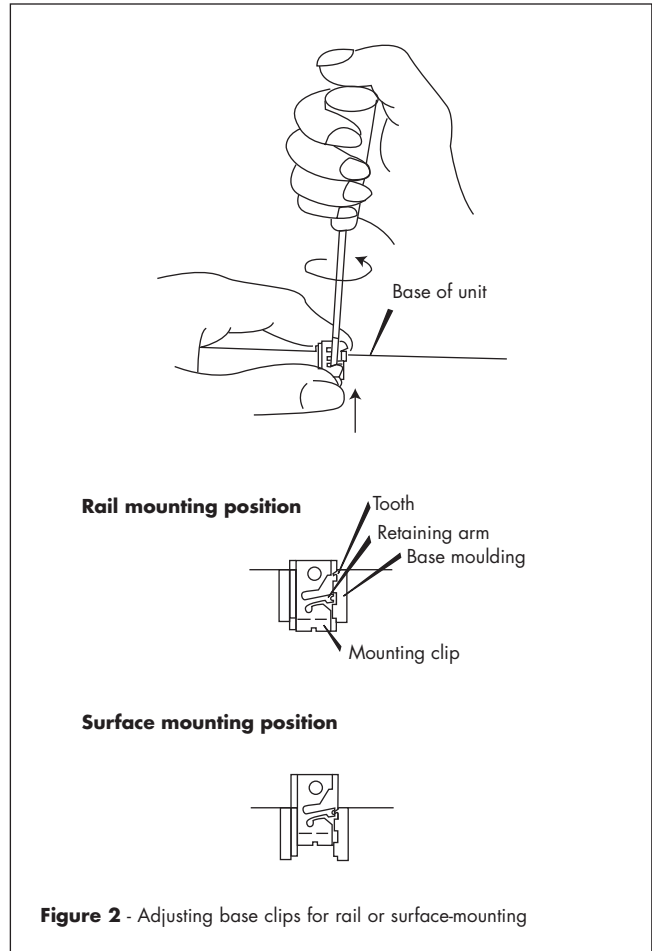

Figure 2 - Adjusting base clips for rail or surface-mounting

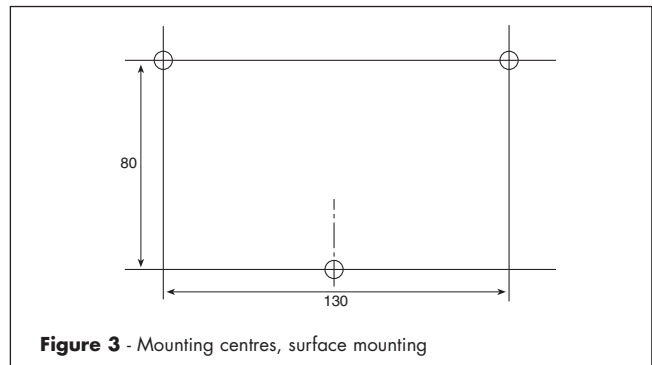

Figure 3 - Mounting centres, surface mounting

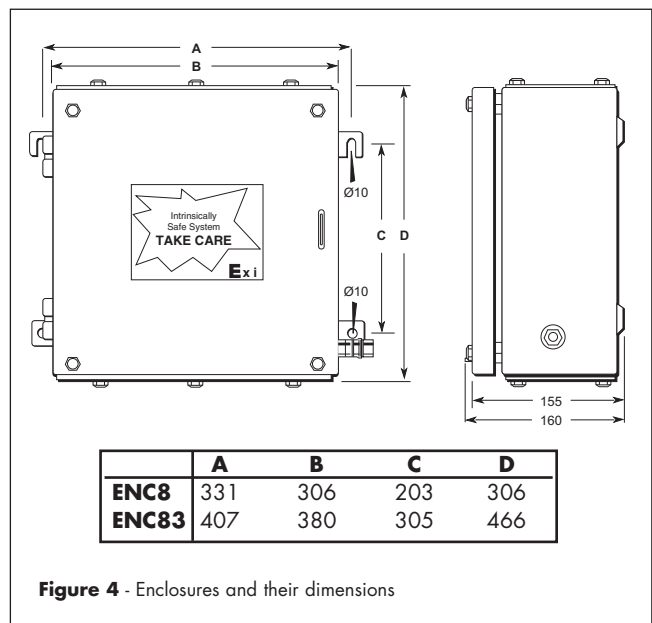

Figure 4 - Enclosures and their dimensions

4 CONNECTIONS

The connection terminals are along the top edges of the multiplexer. These are divided into input sensor terminals (I1 to I16), excitation current source (terminals 7 & 38) and data highway terminals (H1 and H2), as shown in Figure 5.

4.1 RTD inputs

The 15 RTD inputs are split into two banks I1 to I7 and I8 to I15. The operating mode for either bank can be set (see Section 5) to:

- a) 2 or 4-wire mode
- b) 3-wire mode

Because of this, one bank could be used for 3-wire RTDs and the other bank for 2 or 4-wire RTDs.

3-wire RTDs should not be mixed with 2 or 4-wire RTDs in the same bank. *The exception to this rule is when lead compensating resistors are used with 2-wire RTDs for greater accuracy - see next page.*

RTD open circuit failure

The user should be aware that any break in the excitation current circuit will affect all of the RTDs connected to the MTL831B. Consequently, the failure of a single RTD in the simple wiring shown below will cause all the other RTDs to stop operating.

A **solution** to this problem, using signal diodes, is given in MTL publication **AN9010**.

It is important for measurement accuracy that the switches are set correctly for your application. Check them before operation.

4.1.1 2-wire RTDs (see Figure 6)

- 1) Connect up to 15 RTDs to terminal-pairs I1 to I15 (terminals 8 to 37), making sure the polarity is correct.
- 2) Connect a link wire between the +ve lead of each RTD (except the last) and the (adjacent) -ve lead of the next RTD.
- 3) Connect a link wire between the +ve lead of the last RTD and the +ve end of the current loop (terminal 38).
- 4) Connect a link wire between the -ve lead of the first RTD to the -ve end of the current loop (terminal 7).
- 5) To monitor the RTD excitation current, connect terminal 39 to 41 and connect terminal 40 to 42. The unit can then calculate the current from the voltage developed across the built-in 100 ohm resistor.

2-wire RTD - increased measurement accuracy

Lead resistance in 2-wire applications causes inaccuracy. Accuracy can be increased by substituting the wire link (step 2 above) with a resistor equal in value to the resistance of the loop wiring used to connect that RTD. The internal switch must then be set to 3-wire mode for that bank. *This solution must be applied to all RTDs in that bank*

For further details see MTL publication **AN9010**.

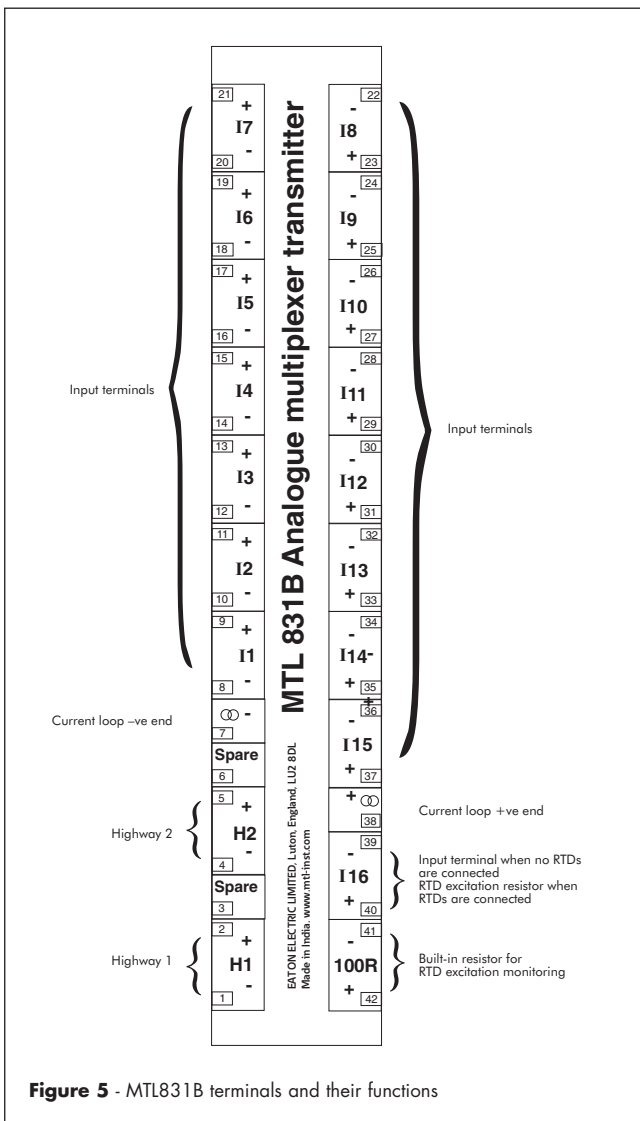

Figure 5 - MTL831B terminals and their functions

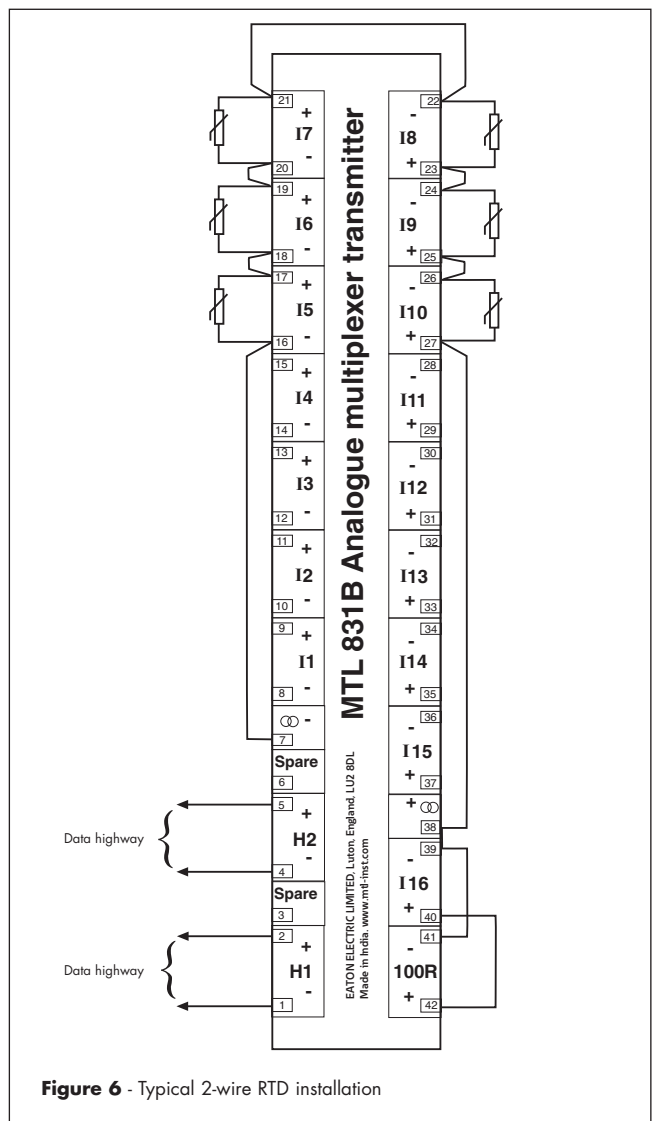

Figure 6 - Typical 2-wire RTD installation

4.1.2 4-wire RTDs (see figure 7)

Wiring 4-wire RTDs requires additional terminal blocks. The ENC83 and ENC83-SS enclosures provide such terminals, as well as earth terminals for all cable screens.

- 1) Connect the 'sense' leads of up to fifteen 4-wire RTDs to the terminal pairs I1 to I15, making sure that the polarity is correct.
- 2) Connect the 'source' leads of the RTDs to the corresponding terminal block pair of the ENC83 enclosure.
- 3) Connect any RTD cable screens to the enclosure's earthing bar.
- 4) Connect a link wire between the +ve source lead of each RTD (except the last) and the -ve source lead of the next RTD.
- 5) Connect the -ve source lead of the first RTD to the -ve end of the current loop (terminal 7).
- 6) Connect the +ve source lead of the last RTD to the +ve end of the current loop (terminal 38).
- 7) To monitor the RTD excitation current, connect terminal 39 to 41 and connect terminal 40 to 42. The unit can then calculate the current from the voltage developed across the built-in 100 ohm resistor.

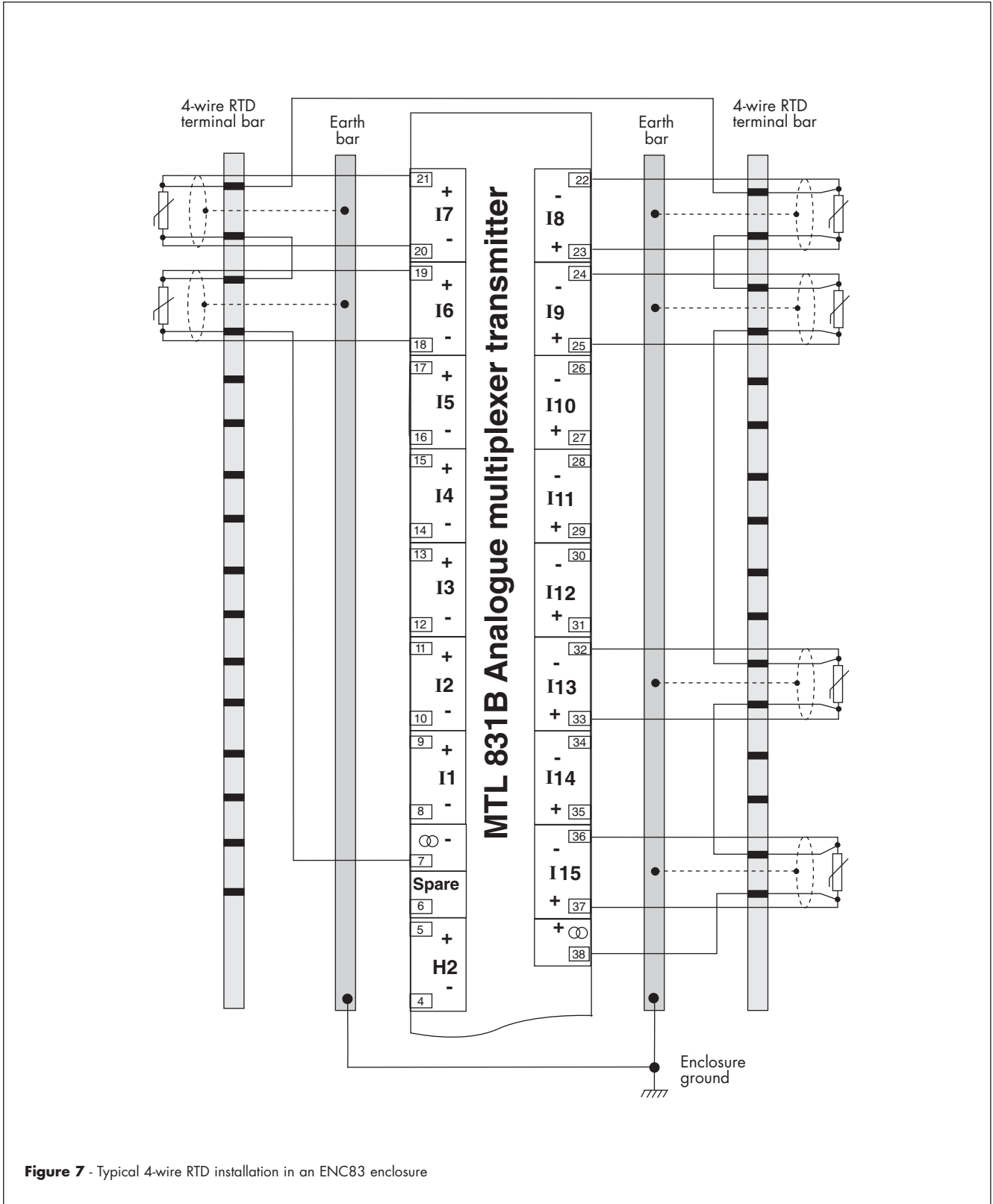

Figure 7 - Typical 4-wire RTD installation in an ENC83 enclosure

4.1.3 3-wire RTDs (see Figure 8)

NOTE 3-wire RTDs cannot be mixed with 2 or 4-wire RTDs in the same terminal bank - see start of Section 4.1 for more details.

- 1) Connect the +ve and -ve leads of up to 15 3-wire RTDs to the terminal pairs **I1** to **I15**, making sure polarity is correct.
- 2) Connect the third (-ve) lead of each RTD, except the first, to the +ve terminal of the previous RTD.
- 3) Connect the third (-ve) lead of the first RTD to the -ve end of the current loop (terminal 7).

Note: If the first RTD does not occupy terminal pair **I1**, the +ve terminal of the preceding terminal pair can be used for linking - as shown in Figure 8.

- 4) Add a link from the +ve terminal of the last RTD to the +ve end of the current loop (terminal 38).
- 5) To monitor the RTD excitation current, connect terminal 39 to 41 and connect terminal 40 to 42. The unit can then calculate the current from the voltage developed across the built-in 100 ohm resistor.

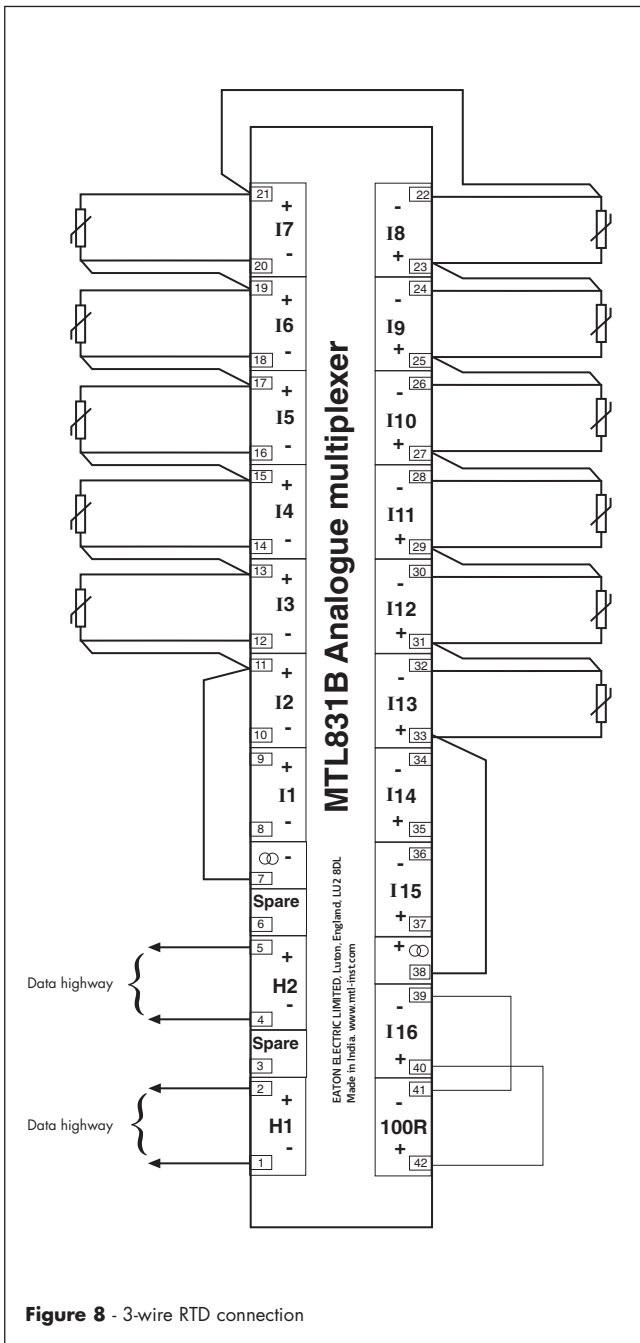

Figure 8 - 3-wire RTD connection

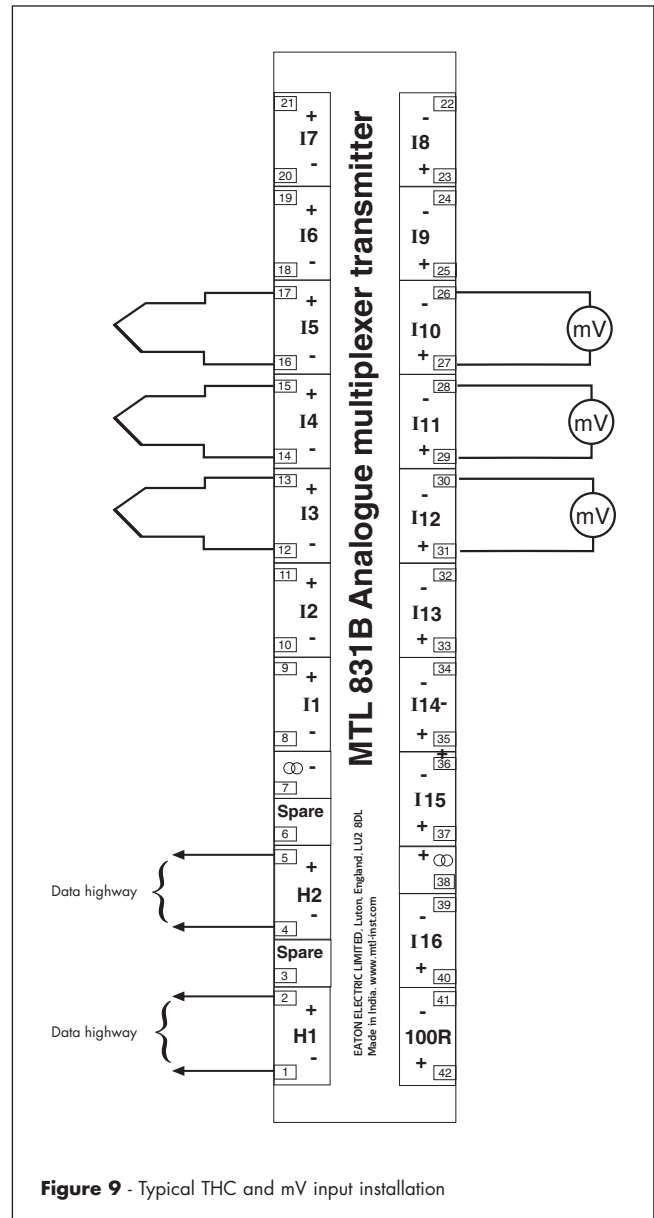

Figure 9 - Typical THC and mV input installation

4.2 THC and mV inputs

Connect up to 16 THC or mV inputs directly to the input terminal pairs **I1** to **I16**, making sure the polarity is correct (see figure 9).

Do not ground the THC or mV sensors unless it can be guaranteed that they all are, and will remain, effectively at the same earth potential.

4.3 Mixed inputs

The ability to mix different input sensor types depends on the configurations available with the MTL838B receiver selected. See the instructions supplied with the MTL838B receiver for details.

Connect the different sensors appropriately, as described in sections 4.1 and 4.2 above.

4.4 Highway connections

The data highway connections H1 (1,2) and H2 (4,5) are also the source of d.c. power for the MTL831B. The user may choose either, or both to provide redundancy.

4.4.1 Transmission distances

The highway length will depend upon two key factors: the type and quality of the cable used, and the level of electrical interference present in the environment.

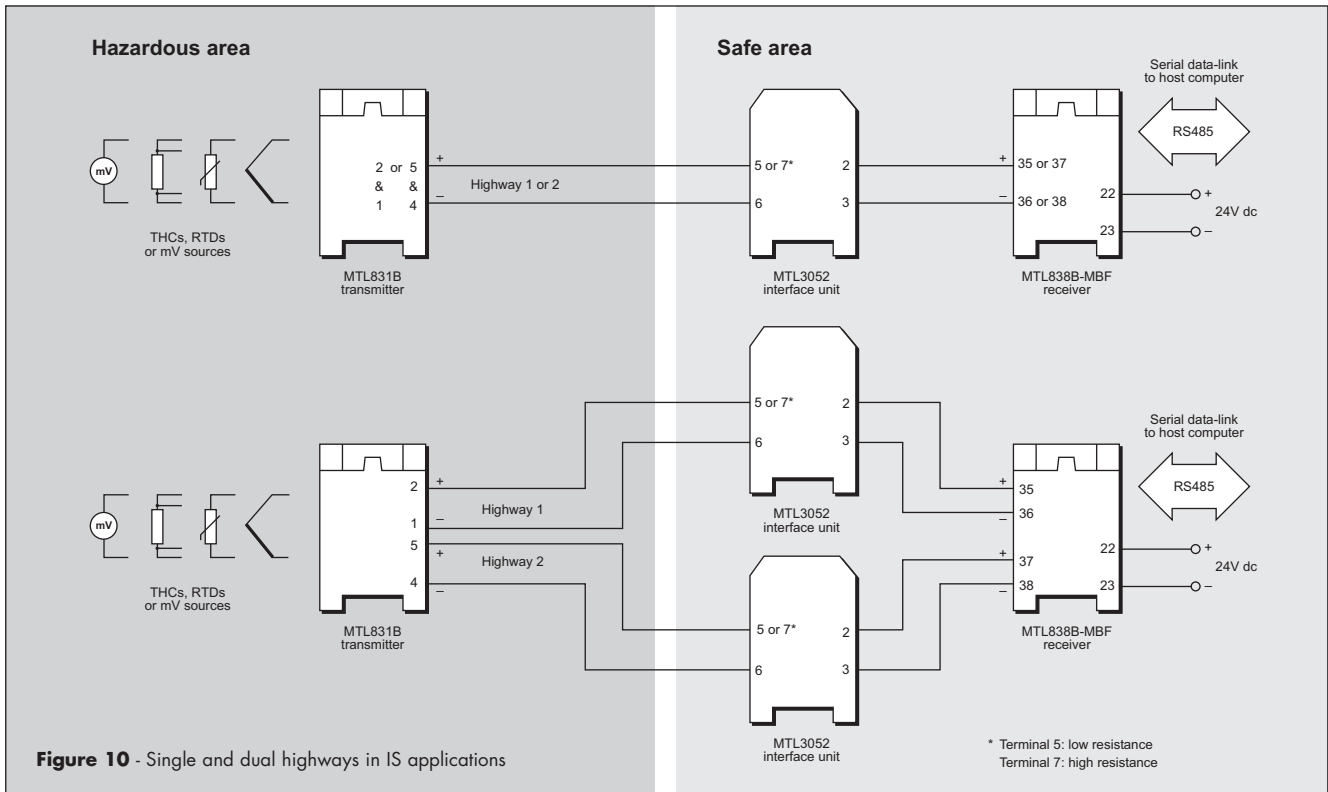

Figure 10 - Single and dual highways in IS applications

Typically a user might expect:

IS applications - 0.5km

Non-IS applications - 1.5km

However, with good quality, screened, twisted-pair cable and an environment that is relatively free from RFI, distances up to 3km have been achieved.

4.4.2 IS applications

For IS applications, the data/power connection must be via a galvanic isolator and so an MTL3052 isolator is connected in-line in the safe area (see Figure 10). One MTL3052 is required for each separate highway.

The -ve and +ve terminals of the H1 (1 & 2) should be connected to the corresponding -ve and +ve terminals of the MTL3052 (6 & 7 respectively) located in the safe area. If a second highway is required for redundancy, connect the H2 (terminals 4 & 5) to a second MTL3052, observing correct polarity.

4.5 MTL3052 digital isolator

The MTL3052 (figure 11) features two output circuits: one with a 15V 180Ω safety description (terminals 7 & 8), and an alternative 15V 100Ω circuit (terminals 5 & 6), which can be used if higher loop resistances need to be accommodated; for example, when surge protectors are incorporated in the data highways. The maximum loop impedance per highway for different applications is shown in Figure 11.

NOTE: In a dual highway configuration, if terminals 5 & 6 are used for both highways, the multiplexer transmitters are restricted to use in IIB atmospheres.

4.6 Multi-transmitter connections

Connect the highway(s) to a receiver for one MTL831B transmitter as in (e). (figure 12)

Connect one or two data highways between output terminal pairs H1 (terminals 1 and 2) and/or H2 (terminals 4 and 5) to the equivalent terminals on a second MTL831B transmitter (terminals 3 and 4 for H1 and terminals 1 and 2 for H2).

NB: two MTL831B transmitters or one MTL831B plus one MTL831 or two MTL832 transmitters can be linked in this way.

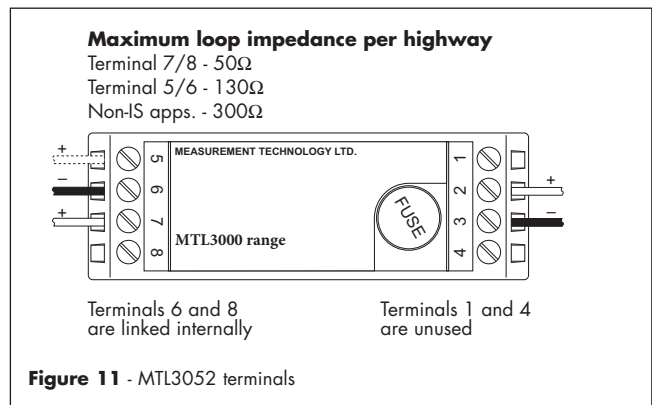

Figure 11 - MTL3052 terminals

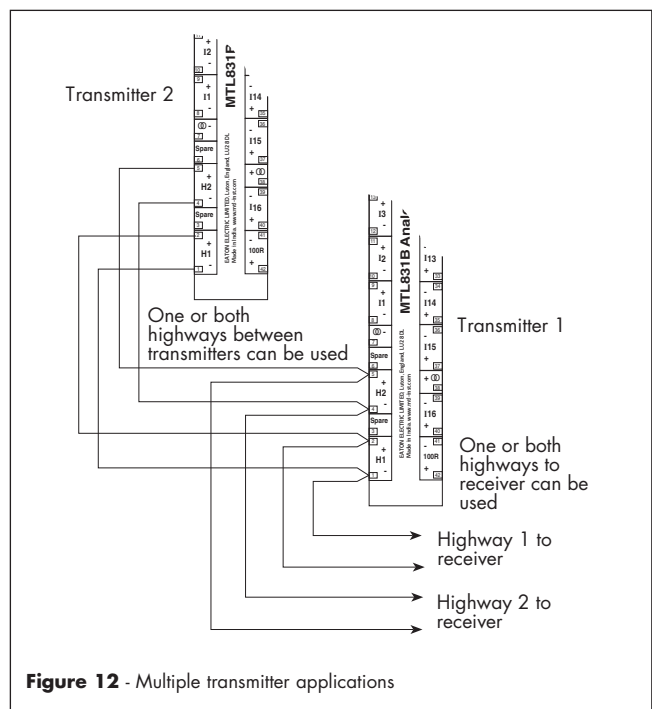

Figure 12 - Multiple transmitter applications

4.7 Cable screens

Screens of sensor cables should be earthed at the MTL831B. If a sensor cable is earthed at the sensor, then it should not be earthed or connected to other screens at the MTL831B.

The screen of a data highway cable between the MTL831B transmitter and MTL3052 isolator is normally connected to an earth rail in the MTL831B's field enclosure. The screen of this cable must not be connected at the MTL3052/MTL838B end of the data highway.

5 CONFIGURATION

Internal switches are used to set the address of the transmitter and the operating mode for RTD sensors. See Figure 13 for details of settings.

Access to the switches is obtained by loosening the captive screws holding the blue terminal strip for terminals 1 to 21, until the strip can be removed. (Replacement of the blue terminal strip is the reverse of its removal instructions).

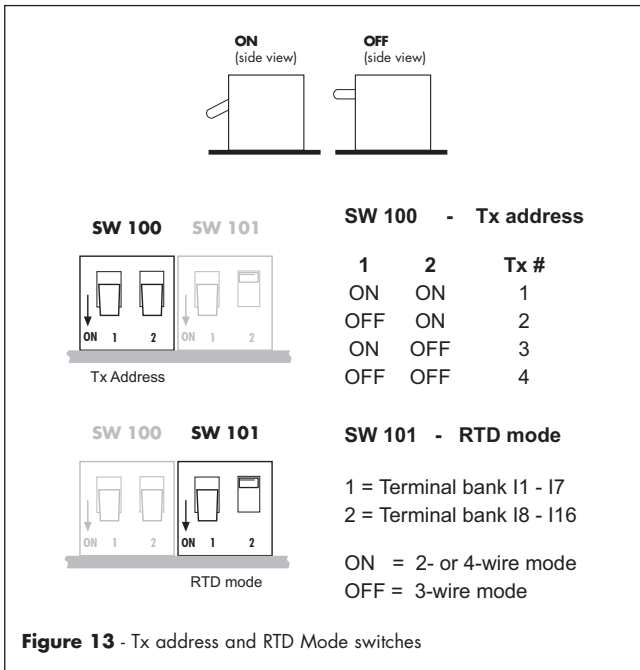

5.1 Transmitter Address

Four addresses (1 to 4) are possible with the SW100 switch settings as shown in Figure 13.

Transmitter addresses must start at address 1 and must be sequential. This means that two transmitters must have addresses 1 and 2, not 1 and 3 or 1 and 4.

If only one transmitter is connected, its switches must be set for transmitter number 1 (ON, ON). Note that this is also the factory default setting.

5.2 RTD mode setting

As mentioned in Section 4.1, the transmitter has two banks of input terminals - **I1** to **I7** and **I8** to **I16**. These two banks of inputs can be set independently, using the switches on SW101, to 3-wire mode (OFF) or 2/4-wire mode (ON) - see Figure 13.

Further documentation

For further information on the MTL831B multiplexer transmitter, MTL838B multiplexer receiver and the MTL3052 data highway isolator, refer to:

- MTL831B** data sheet in catalogue
- MTL838B-MBF** data sheet in catalogue
- INM838B** MTL838B-MBF instruction manual
- MTL3052** data sheet in catalogue

The above documents are available from our web site

<http://www.mtl-inst.com>

6. ATEX INFORMATION

The Essential Health and Safety Requirements (Annex II) of the EU Directive 2014/34/EU [the ATEX Directive - safety of apparatus] requires that the installation manual of all equipment used in hazardous areas shall contain certain information. This annex is included to ensure that this requirement is met. It compliments the information presented in this document and does not conflict with that information. It is only relevant to those locations where the ATEX Directives are applicable.

6.1 General

- In common with all other electrical apparatus installed in hazardous areas, this apparatus must only be installed, operated and maintained by competent personnel. Such personnel shall have undergone training, which included instruction on the various types of protection and installation practices, the relevant rules and regulations, and on the general principles of area classification. Appropriate refresher training shall be given on a regular basis. [See clause 4.2 of EN 60079-17].
- The apparatus has been designed and manufactured in accordance with EN 50014 and EN50020. The MTL831B transmitter is certified 'ia' and is normally mounted in a Zone 1 hazardous area. The MTL3052 meets the requirements of Associated Apparatus for category 'ia' and is always mounted in the safe area.
- This apparatus has been designed and manufactured so as to provide protection against all the relevant additional hazards referred to in Annex II of the directive, such as those in clause 1.2.7.

6.2 Installation

- The installation should comply with the appropriate European, national and local regulations, which may include reference to the IEC code of practice IEC 60079-14. In addition particular industries or end users may have specific requirements relating to the safety of their installations and these requirements should also be met. For the majority of installations the Directive 1999/92/EC [the ATEX Directive - safety of installations] is also applicable.
- This apparatus must not be subjected to mechanical and thermal stresses in excess of those permitted in the certification documentation, this manual and the product specification. If necessary the product must be protected by an enclosure to prevent mechanical damage.

- The apparatus must not be installed in a position where it may be attacked by aggressive substances and must be protected from excessive dust, moisture and other contaminants.

6.2.1 MTL831B

This is IS apparatus and is normally mounted in a hazardous area. It meets the requirement of Category 1 apparatus and may be installed in a Zone 0 or a Zone 1 location, provided that the relevant installation requirements are met.

6.2.2 MTL3052

This is associated apparatus and is always mounted in a safe area.

6.3 Inspection and maintenance

- Inspection and maintenance should be carried out in accordance with European, national and local regulations which may refer to the IEC standard IEC 60079-17. In addition specific industries or end users may have specific requirements which should also be met.
- Access to the internal circuitry must not be made during operation.
- If the outer enclosure of the apparatus needs to be cleaned, this should be done with a cloth lightly moistened by a dilute mixture of detergent in water.

6.4 Repair

- This product cannot be repaired by the user and must be replaced with an equivalent certified product. Repairs should only be carried out by the manufacturer or his authorised agent.

6.5 Marking

- The products are labelled in a manner reproduced below. In addition, the serial number and/or date of manufacture are marked on the individual apparatus.

This manual applies to products manufactured and date marked during or after the year 2004.



CROUSE-HINDS
SERIES

MTL831B analogue multiplexer transmitter

 Baseefa 03ATEX0006X $U_i \leq 30V$, $I_i \leq 300mA$, $P_i \leq 1.2W$
II 1 G EEx ia IIC T4 $-20^\circ C \leq T_a \leq +60^\circ C$

 Intrinsicly Safe apparatus for Class I, Division 1, Group A,B,C and D in accordance with entity requirements and MTL Installation Drawing SCI-245; nonincendive for Class I, Division 2, Group A,B,C and D hazardous indoor locations.

Ex ia CI, I, Groups A,B,C,D, Div. 1, hazardous locations (Refer to Drawing SCI-243 for Applicable Groups and Installation Instructions.) "INTRINSICALLY SAFE"
"SECURITE INTRINSEQUE." Temperature Code T4 @ Max. Ambient 60°C.

 Supply 15V dc max, 300mA max or 30V dc max, 150mA max.
WARNING: SUBSTITUTION OF COMPONENTS MAY IMPAIR INTRINSIC SAFETY
AVERTISSEMENT: LA SUBSTITUTION DE COMPOSANTS PEUT COMPROMETTRE LA SECURITE INTRINSEQUE.

WARNING:-
ELECTROSTATIC HAZARD CLEAN ONLY WITH A MOIST CLOTH AND DETERGENT.

EATON ELECTRIC LTD, Luton, England, LU2 8DL
Made in India. www.mtl-inst.com





CROUSE-HINDS
SERIES

MTL3052 digital isolator

 II (1) G [EEx ia] IIC
Baseefa03ATEX0034
 $U_m = 250V$
 $-20^\circ C \leq T_a \leq 60^\circ C$

MTL INSTRUMENTS PVT LTD.
Chennai, India. Made in India.



AUSTRALIA

MTL Instruments Pty Ltd,
10 Kent Road, Mascot, New South Wales, 2020, Australia
Tel: +61 1300 308 374 Fax: +61 1300 308 463
E-mail: mtl-salesanz@eaton.com

BeNeLux

MTL Instruments BV
Ambacht 6, 5301 KW Zaltbommel
The Netherlands
Tel: +31 (0)418 570290 Fax: +31 (0)418 541044
E-mail: mtl.benelux@eaton.com

CHINA

Cooper Electric (Shanghai) Co. Ltd
955 Shengli Road, Heqing Industrial Park
Pudong New Area, Shanghai 201201
Tel: +86 21 2899 3817 Fax: +86 21 2899 3992
E-mail: mtl-cn@eaton.com

FRANCE

MTL Instruments sarl,
7 rue des Rosiéristes, 69410 Champagne au Mont d'Or
France
Tel: +33 (0)4 37 46 16 53 Fax: +33 (0)4 37 46 17 20
E-mail: mtlfrance@eaton.com

GERMANY

MTL Instruments GmbH,
Heinrich-Hertz-Str. 12, 50170 Kerpen, Germany
Tel: +49 (0)22 73 98 12-0 Fax: +49 (0)22 73 98 12-2 00
E-mail: csckerpen@eaton.com

INDIA

MTL India,
No.36, Nehru Street, Off Old Mahabalipuram Road
Sholinganallur, Chennai- 600 119, India
Tel: +91 (0) 44 24501660 /24501857 Fax: +91 (0) 44 24501463
E-mail: mtlindiasales@eaton.com

ITALY

MTL Italia srl,
Via San Bovio, 3, 20090 Segrate, Milano, Italy
Tel: +39 02 959501 Fax: +39 02 95950759
E-mail: chmninfo@eaton.com

JAPAN

Cooper Crouse-Hinds Japan KK,
MT Building 3F, 2-7-5 Shiba Daimon, Minato-ku,
Tokyo, Japan 105-0012
Tel: +81 (0)3 6430 3128 Fax: +81 (0)3 6430 3129
E-mail: mtl-jp@eaton.com

NORWAY

Norex AS
Fekjan 7c, Postboks 147,
N-1378 Nesbru, Norway
Tel: +47 66 77 43 80 Fax: +47 66 84 55 33
E-mail: info@norex.no

RUSSIA

Cooper Industries Russia LLC
Elektrozavodskaya Str 33
Building 4
Moscow 107076, Russia
Tel: +7 (495) 981 3770 Fax: +7 (495) 981 3771
E-mail: mtlrussia@eaton.com

SINGAPORE

Cooper Crouse-Hinds Pte Ltd
No 2 Serangoon North Avenue 5, #06-01 Fu Yu Building
Singapore 554911
Tel: +65 6645 9864 / 6645 9865 Fax: +65 6 487 7997
E-mail: sales.mtlsing@eaton.com

SOUTH KOREA

Cooper Crouse-Hinds Korea
7F, Parkland Building 237-11 Nonhyun-dong Gangnam-gu,
Seoul 135-546, South Korea.
Tel: +82 6380 4805 Fax: +82 6380 4839
E-mail: mtl-korea@eaton.com

UNITED ARAB EMIRATES

Cooper Industries/Eaton Corporation
Office 205/206, 2nd Floor SJ Towers, off. Old Airport Road,
Abu Dhabi, United Arab Emirates
Tel: +971 2 44 66 840 Fax: +971 2 44 66 841
E-mail: mtlgulf@eaton.com

UNITED KINGDOM

Eaton Electric Ltd,
Great Marlings, Butterfield, Luton
Beds LU2 8DL
Tel: +44 (0)1582 723633 Fax: +44 (0)1582 422283
E-mail: mtlenquiry@eaton.com

AMERICAS

Cooper Crouse-Hinds MTL Inc.
3413 N. Sam Houston Parkway W.
Suite 200, Houston TX 77086, USA
Tel: +1 281-571-8065 Fax: +1 281-571-8069
E-mail: mtl-us-info@eaton.com